

Start

Side
A

Side
B

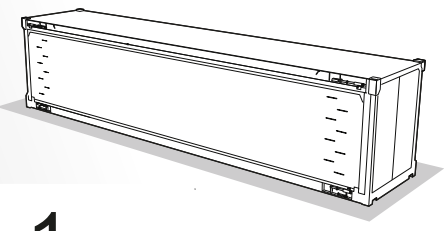
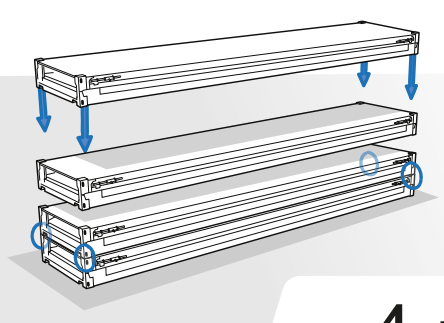
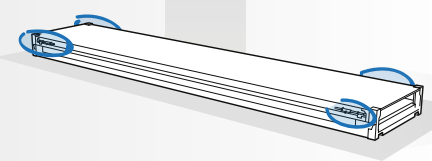
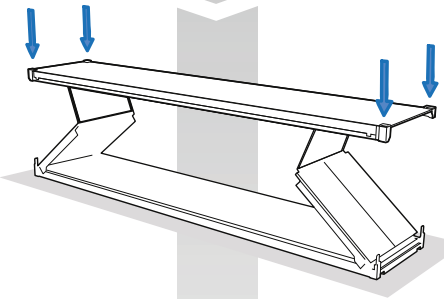
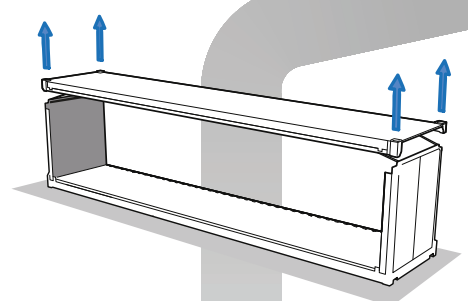
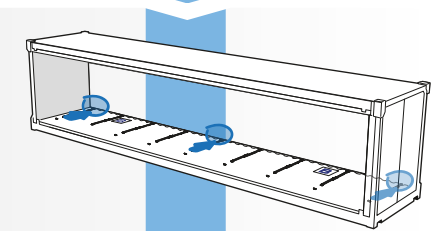
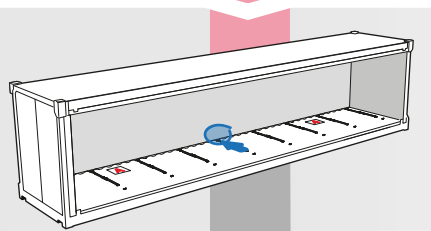
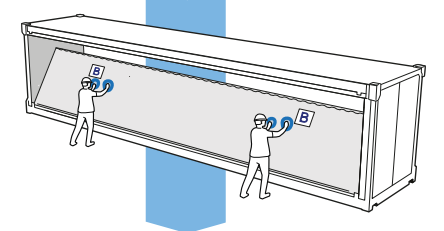
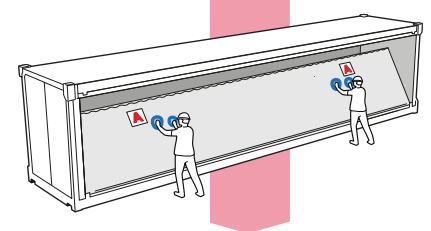
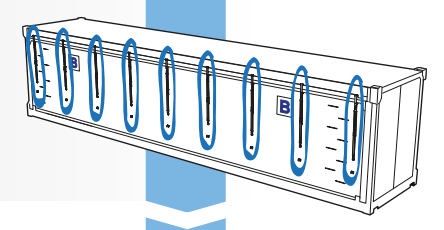
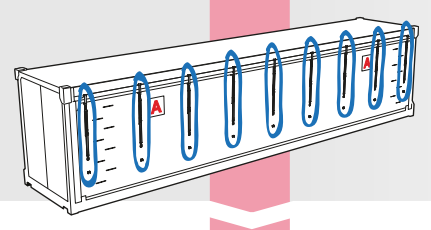
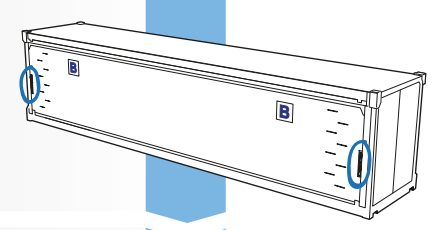
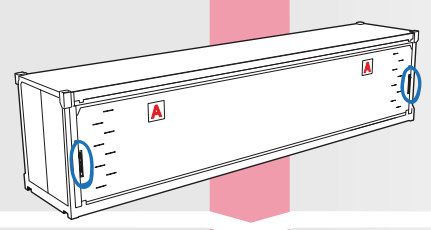
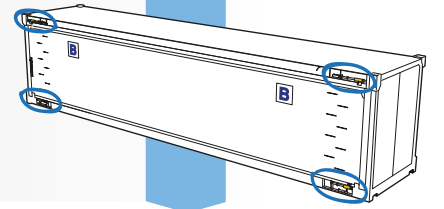
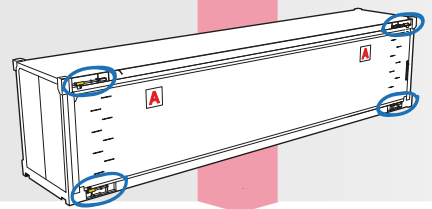
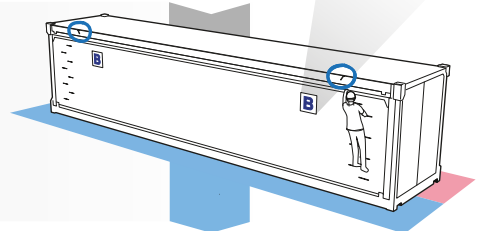
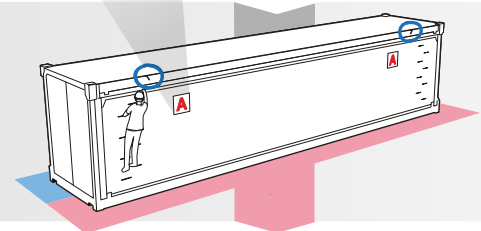
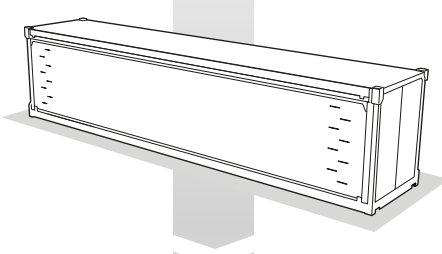
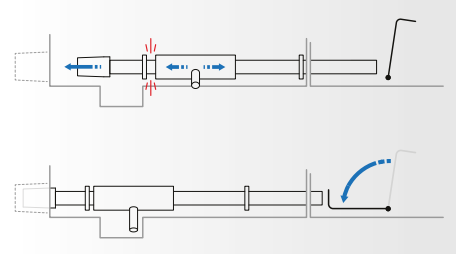
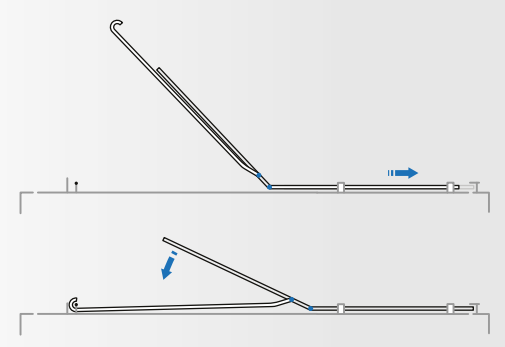
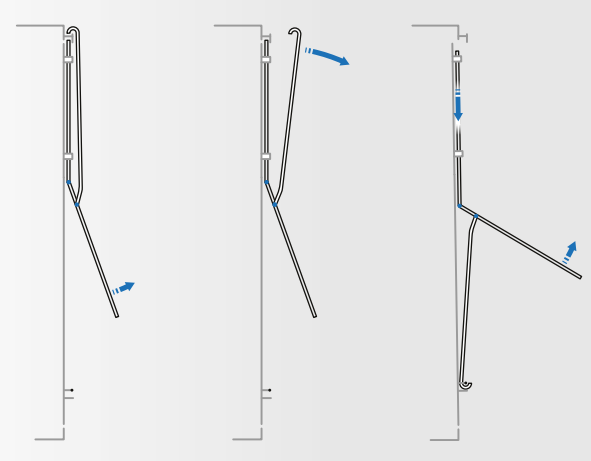
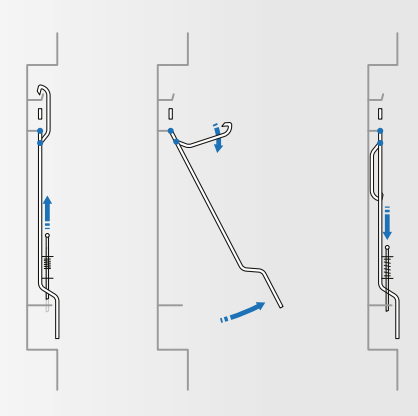
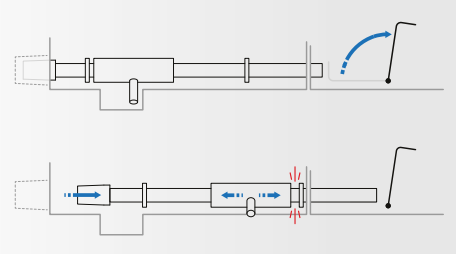

4 = 1

